

IF IN DOUBT ASK!

DO NOT SCALE PRINT!

DRAWING TO BS 8888

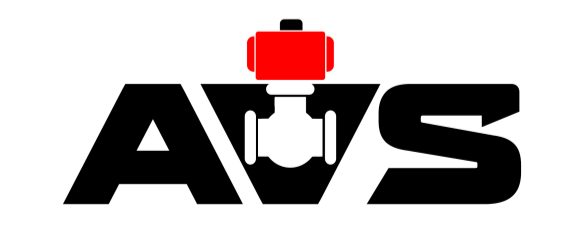
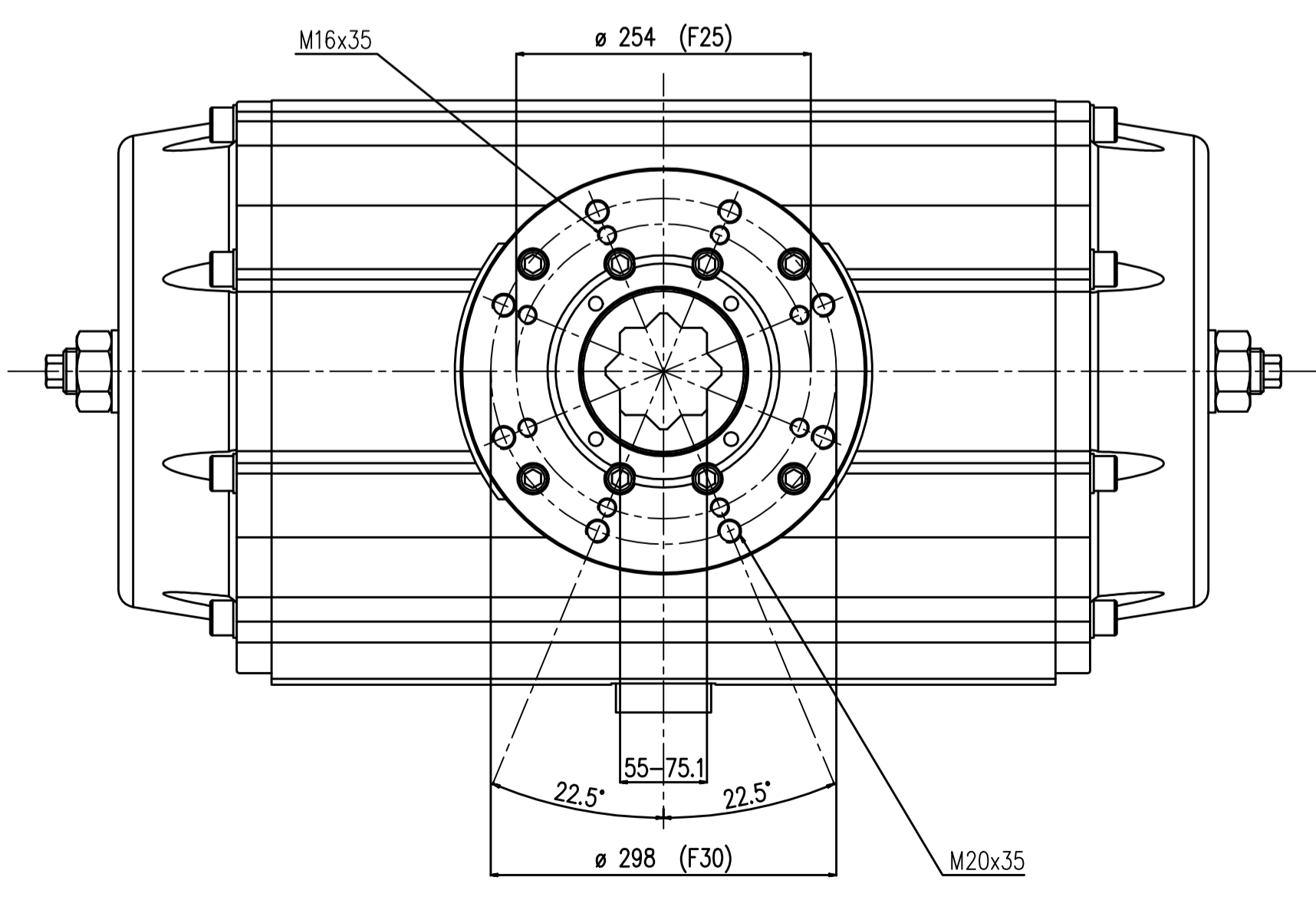
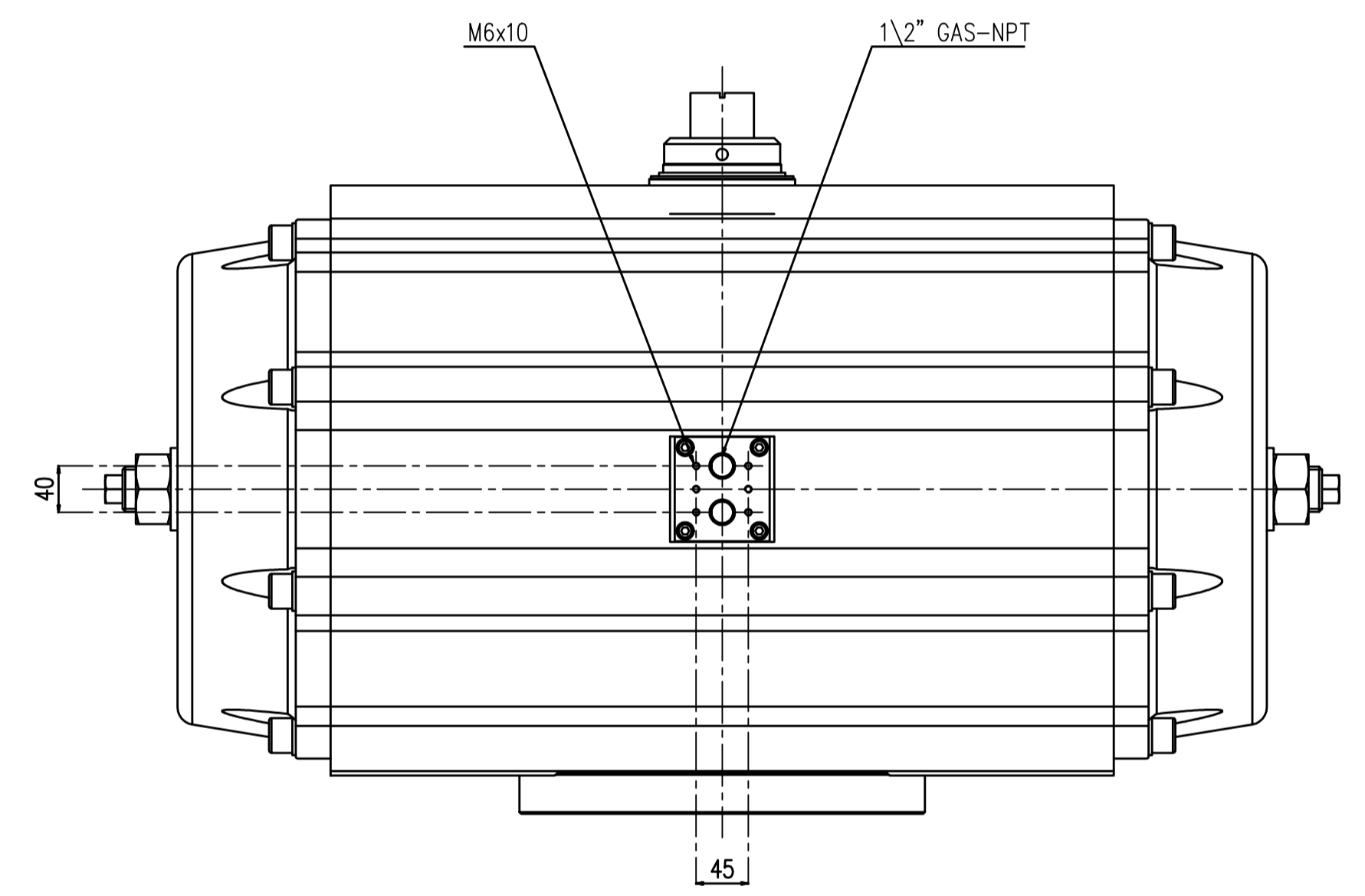
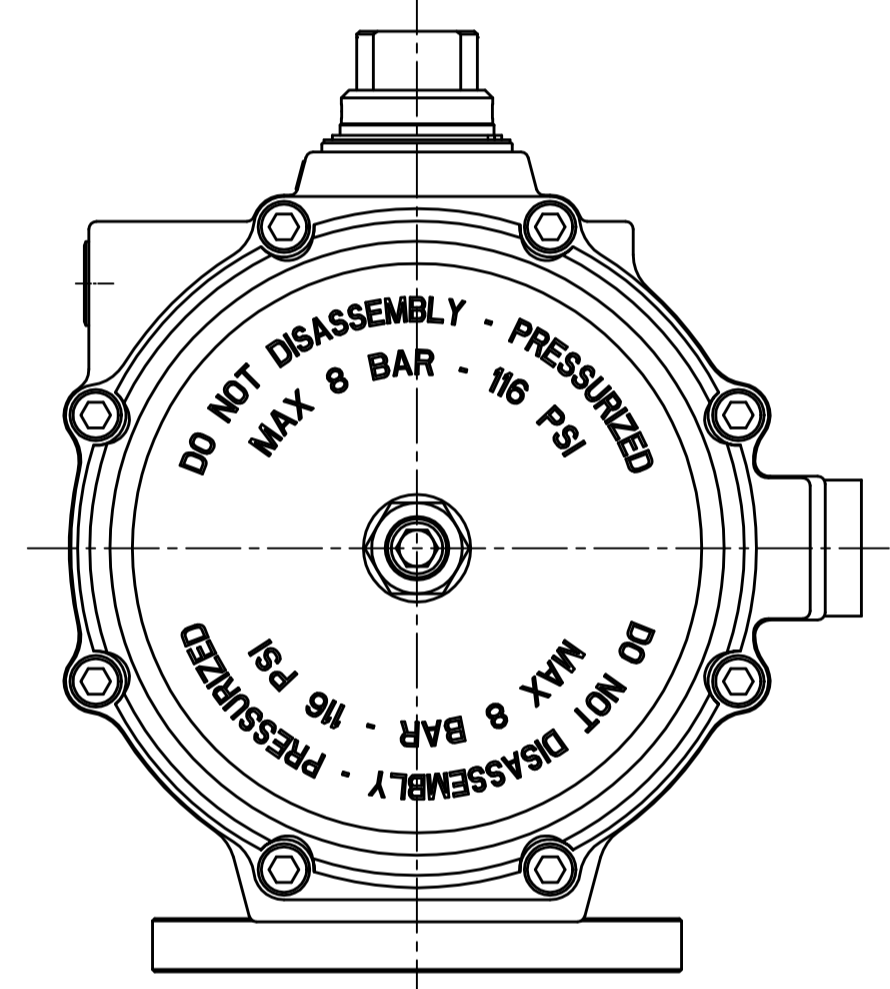
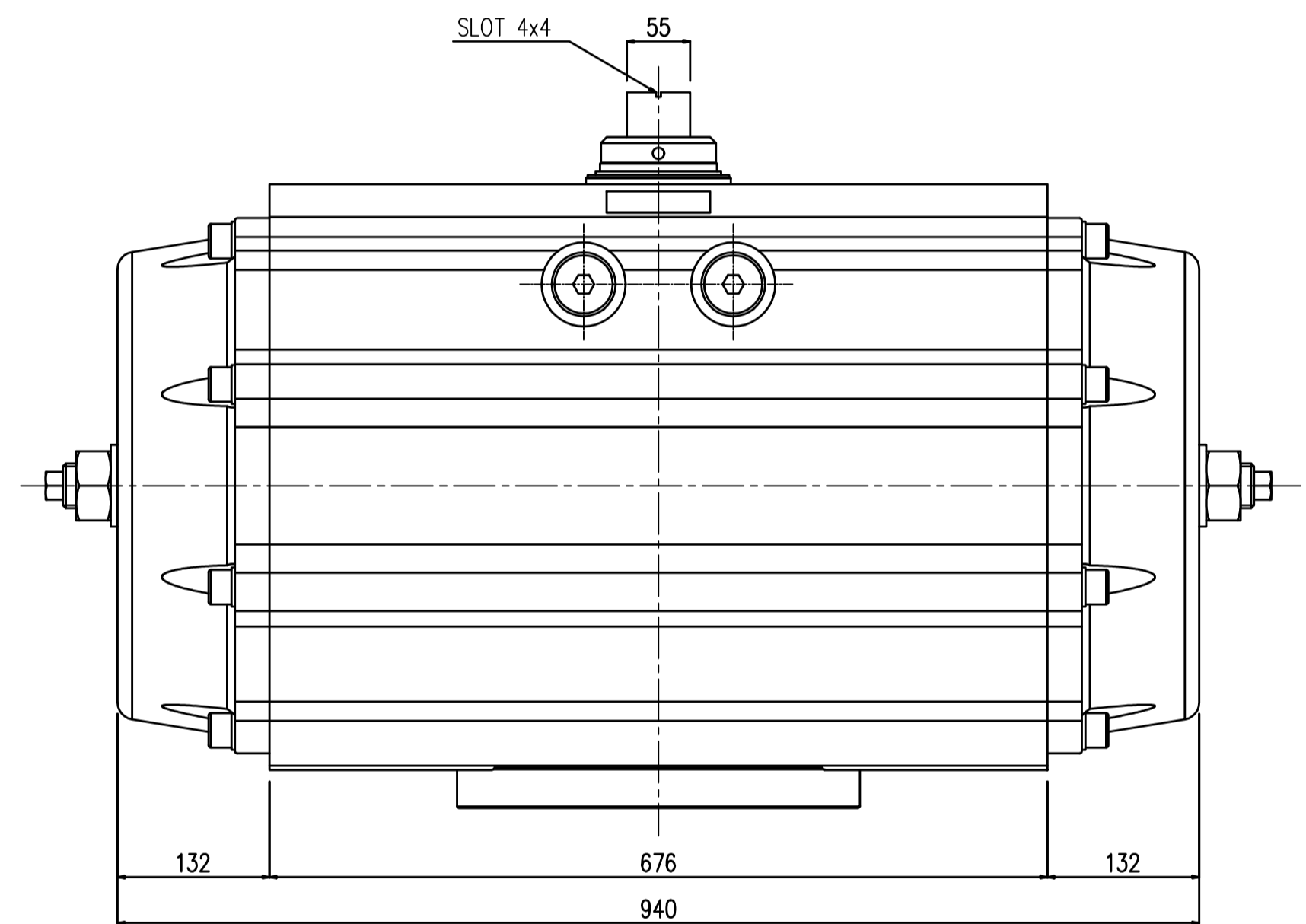
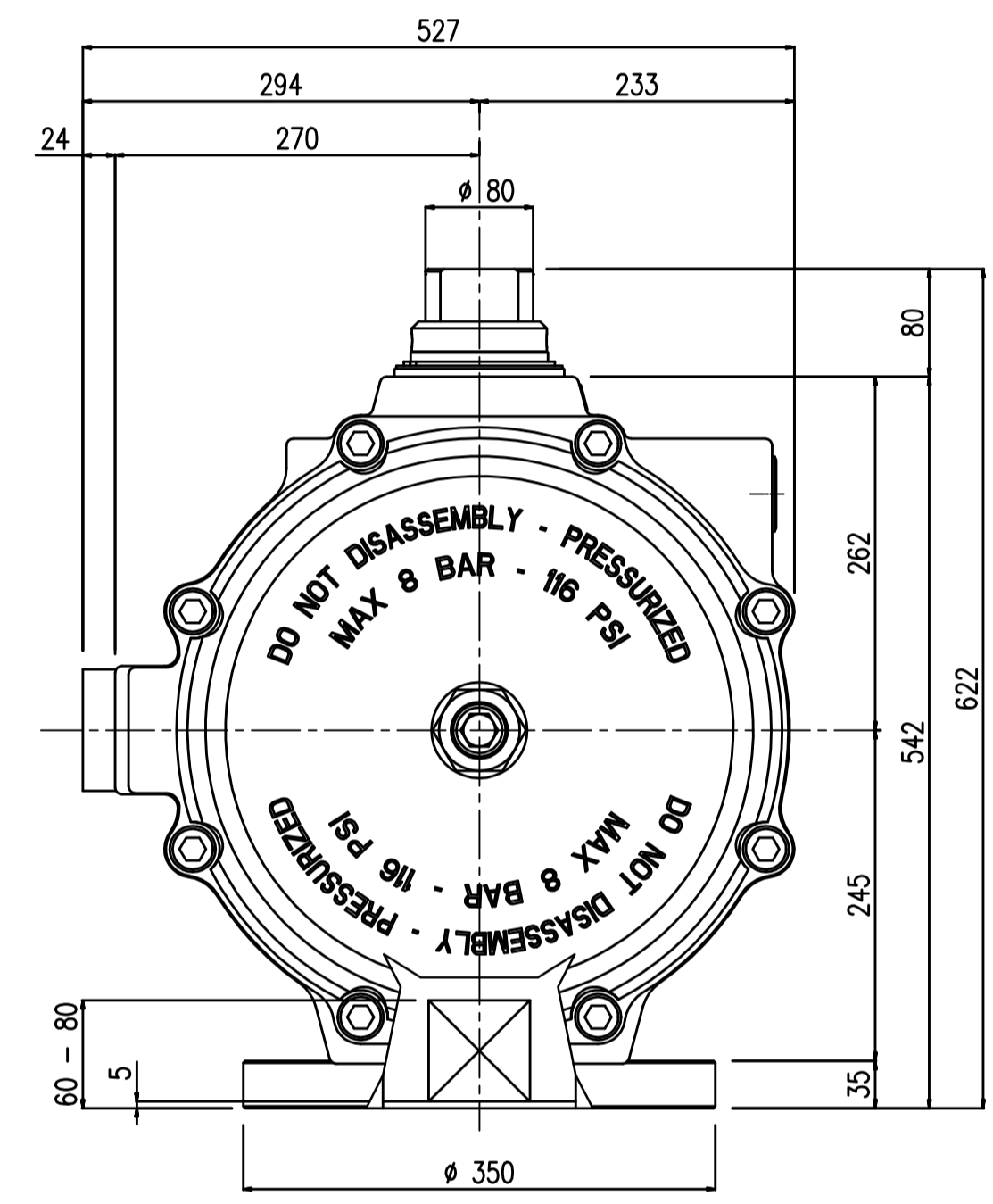
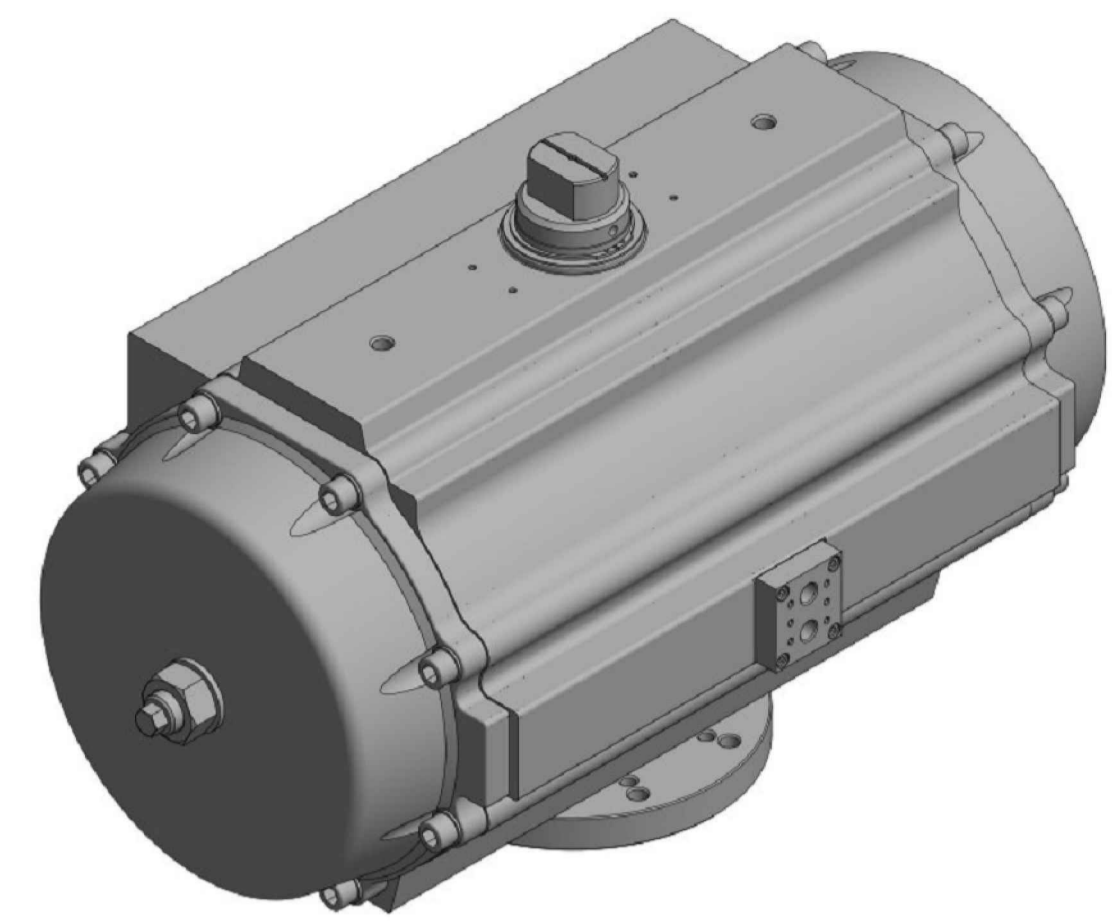
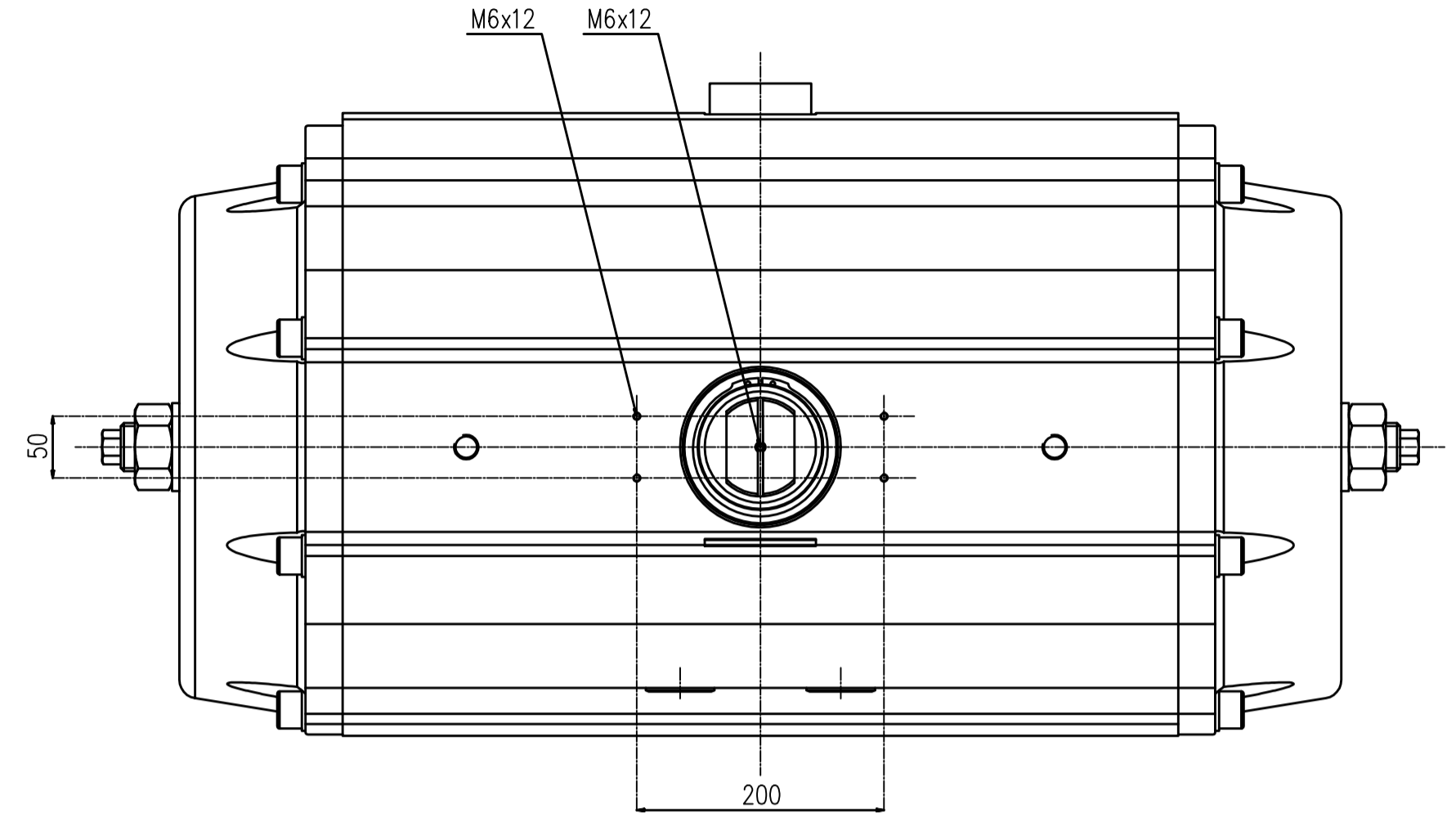

THIS DRAWING IS CONFIDENTIAL AND IS NOT TO BE REPRODUCED WITHOUT THE WRITTEN CONSENT OF Actuated Valve Supplies Limited

TITLE CH-air MODEL A-420 PNEUMATIC ACTUATOR - ALUMINIUM

STOCK CODE CH-AIR-A-420-CAD DIM ARE mm SCALE 1:5

JRM	HMM	SBW	NEW		30.08.17
APPROVED BY	CHECKED BY	DRAWN BY	ISSUE	CHANGE NO.	DATE
CH-AIR-A-420-CAD					
DRAWING NUMBER					SHEET 1 OF 1