

VALPES ER60 PREMIER



Overview

The ER60 PREMIER multi-voltage electric valve actuator from the European electric actuator manufacturer VALPES offers an impressive list of standard features that include multi-voltage capability, protection against damage from over-torque or condensation, and emergency hand operation facility.

ER60 PREMIER VALPES Electric Actuator Specifications

Voltage range / Duty rating	Low voltage version	24V DC / 30%
	High voltage version	24V AC (1ph) or DC / 30% 100 - 240V AC (1ph) / 30% 100 - 350V DC / 30%
Operating time (0-90° no load)	With load	15 seconds
Maximum break torque	Max including safety	60 Nm (531 lb.ins)
IP Rating (IEC 60529)		IP65
Working angle Standard (on request)		90°
Mounting ISO:5211 x DIN 3337		F03, F04 & F05 x 14 (std)
Motor switches		2 x SPDT micro switches (5A Max)
End of travel confirmation (volt free)		2 x SPDT micro switches (5A Max)
Heater		Yes
Ambient temperature range		-10° to +55°C (14 to +131°F)
Electrical connections		1 x DIN 7 1 x M20
Weight		2.1 kg
Consumption		
Power		45W

How this ER60 PREMIER electric 1/4 turn valve actuator works (on-off)

Electrically operated valves are driven by an electric actuator containing a motor and gearbox. On receipt of a continuous voltage signal (not pulse) the motor runs and, via a gearbox in the electric actuator, rotates the valve stem. The motor stops at the desired position (usually 0° or 90°) by an internal cam striking a micro-switch. The valve actuator remains in this position, with the voltage still applied continuously, until switched and a continuous voltage reversing signal (not pulse) is applied, which runs the motor in the opposite direction, reversing the rotation until a separate internal cam strikes a separate micro-switch and stop the motor. The ER60 PREMIER actuator is designed to have the external power continuously applied, and power must not be switched off when end of travel is achieved.

ER60 PREMIER ON - OFF ELECTRIC ACTUATOR Power open, power close, stays put on loss of external power.

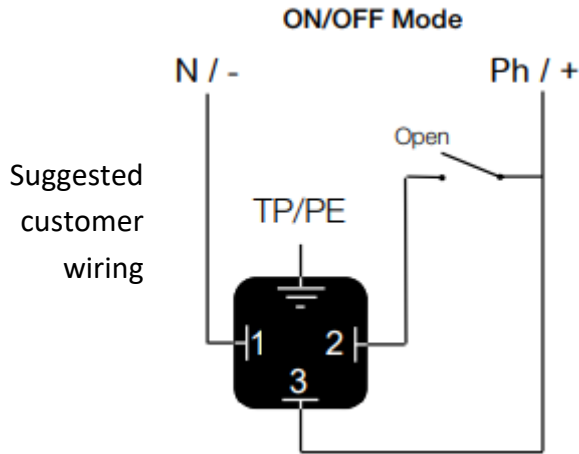

Electrical Connections

FCO	Open position limit switch
FCF	Closed position limit switch
FC1	Open indication limit switch
FC2	Closed indication limit switch

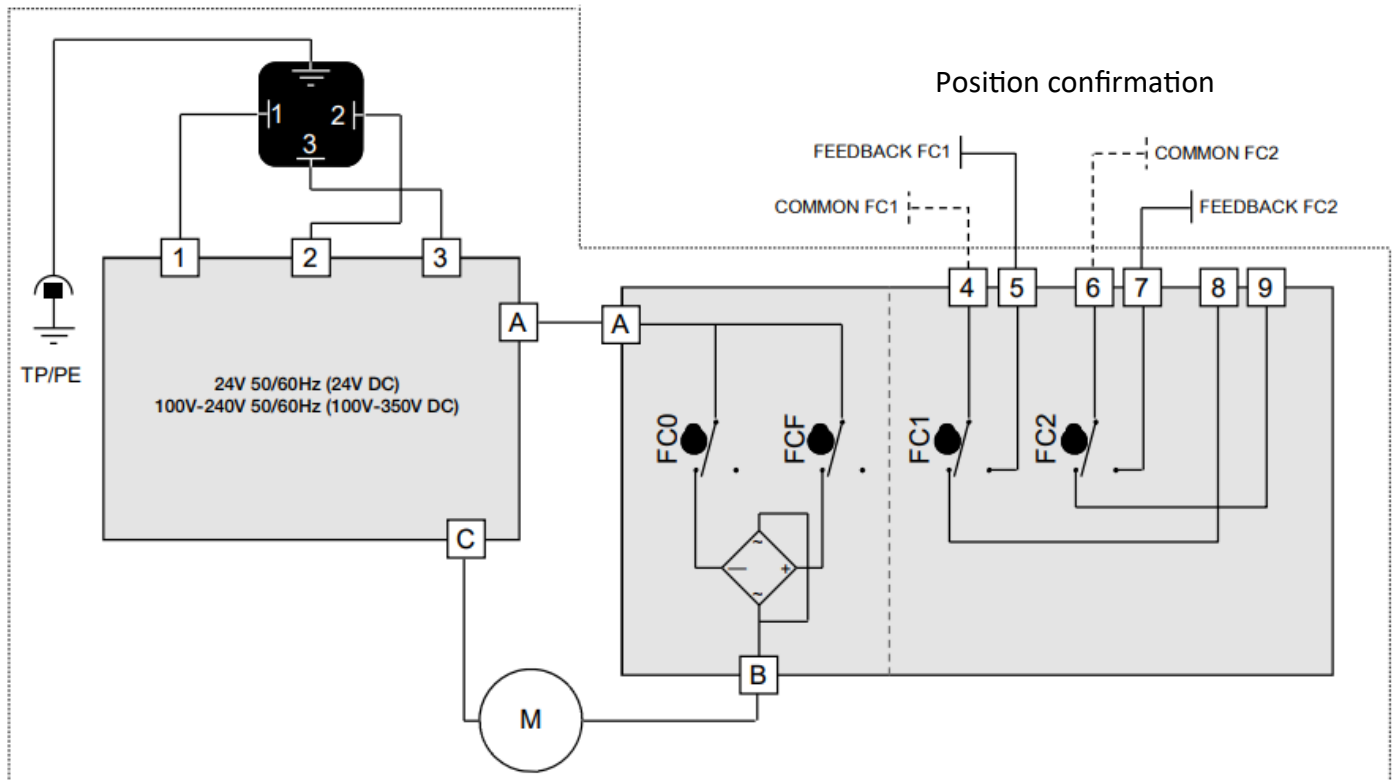

ER PREMIER Series Dimensions

